

# OWNER'S MANUAL

## CRS8 SERIES

CRS8 One / CRS8 Two / CRS8 Three / CRS8 Four

### Custom Round Series In-Ceiling Loudspeakers

Congratulations on your purchase of SpeakerCraft CRS8 In-Ceiling Speakers. All CRS8 speakers are equipped with pivoting tweeters, which allow you to direct the sound toward, or away from, a listening area to achieve a desired effect. In addition, each CRS8 model features SpeakerCraft's revolutionary WavePlane™ tweeter baffle. SpeakerCraft has a wide variety of accessories to compliment your CRS Series speakers. Contact your dealer or SpeakerCraft direct for more details.

#### SPEAKER PLACEMENT

Before installing your speakers, you should consider the placement carefully, taking into account the location of electrical, plumbing and other fixtures. Contact your dealer for assistance if you are not sure of the best location in your particular room environment.

**Placement In Ceiling:** When placing your speakers in the ceiling, they should ideally be located above the primary listening area. The unique tweeter baffle of the CRS8 speakers allows for more forward radiation and a more even frequency response than is obtainable on conventional coaxial type round speakers. (See Diagram 1) If the speakers are positioned far away from the primary listening area, adjust the pivoting tweeter so they are pointed at the primary listening area. **Note:** To avoid possible damage to the pivoting tweeters, read the section entitled "SPEAKER ADJUSTMENTS" in this manual prior to performing the tweeter adjustment.

**WavePlane™**  
TECHNOLOGY

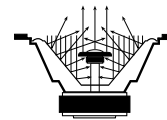

**Standard Co-Axial**  
No Tweeter Baffle  
Uneven Forward Dispersion  
which causes distortion

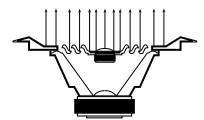

**WavePlane™ Technology**  
95% Solid Plane for Tweeter  
80% Open Area for Woofer  
Even dispersion, less distortion

Diagram 1

In a very large room with high ceilings, it may be necessary to place additional speakers throughout the room. Contact your Authorized SpeakerCraft dealer for assistance.

#### MOUNTING SURFACE PREPARATION

##### New Construction — Unfinished Ceilings

A New Construction Bracket, SpeakerCraft P/N BKT90681 (available from your dealer), may be installed prior to drywall application across joists (up to 24" on-center) where a speaker will be located. Insulation material should be in place prior to installing drywall. After the hole is cut and the drywall is installed, the speakers are then easily installed following the instructions for mounting in "Finished Ceilings". **Note:** If the speakers are to be mounted more than 24" on-center, a special "Extra Long Wing", SpeakerCraft P/N WING90224, is available from your dealer.

##### Finished Ceilings

Prior to the actual installation of the speakers, it will be necessary to run cables to the speaker locations. See your dealer for more information about cable installation. After the cable has been properly installed, you are ready to mount the speakers. Following the simple steps listed below will result in a professional looking installation:

1. Determine the best area to mount your speakers. This area of the ceiling should be free of obstructions such as electrical conduit, HVAC ducts, or water lines. This can best be determined by noting the placement of fixtures and gaining access to an attic or crawl space for further analysis of the location of such obstacles.
2. Find the joists nearest the desired speaker mounting location. We highly recommend using a good stud-finder tool for this procedure. If you are lining up the speakers to some other object or molding in the room, make sure you consider the size of the baffle flange which extends beyond the mounting hole.
3. Mark the hole. A template for setting the hole is provided in the box (along with two paint mask inserts for use when painting). Position the template in the desired position and pencil an outline on the ceiling.

SpeakerCraft®

4. Cutting the hole. **CAUTION:** This is the most important part of the entire installation. If you are uncertain whether any obstructions exist behind the desired mounting area, you should start by cutting a small hole in the center of your penciled mounting hole with a drywall saw, cutting at a 45° angle towards the inside of the hole. (See Diagram 2) Cutting the small hole at this angle will make drywall repair much easier, using the piece cut out. Once you have determined that there aren't any obstructions in your desired mounting location, start cutting the finished hole at a 90° angle to the ceiling surface.
5. Add insulation. If the area in the ceiling is not already insulated, add an adequate amount insulation material to loosely cover the back of the speaker. If the insulation material used is faced with foil or paper, position the foil or paper away from the speaker.

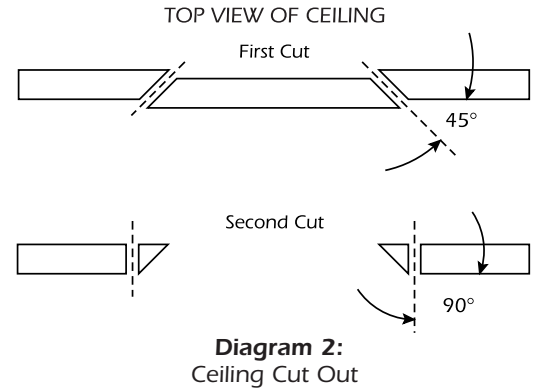

## SPEAKER ADJUSTMENTS

Your CRS8 speakers come from the factory with the tweeter facing straight out from the baffle. This will result in the overall smoothest response. However, depending on your particular primary area, room acoustics, ceiling height, or personal preference, you may find the sound more pleasing by pointing the tweeters in a particular direction. If additional treble is desired in the primary listening area, point the tweeter towards that area; and if less treble is required, point the tweeter away. Push gently at the edge of the tweeter to point it in the desired direction. (See Diagram 3) **CAUTION:** Avoid touching tweeter dome as damage WILL occur on metal dome tweeters (CRS8 Three & Four).

### Treble Adjustment (CRS8 Two, Three & Four):

The switch labeled TREBLE allows for 6dB of treble (high frequency) adjustment. Your speakers were shipped with the treble switch in the neutral position, providing the most linear frequency response. If you desire more treble, roll the switch to the "+" position, and the tweeter will play 3dB higher. If you want less treble, roll the switch to the "-" position and the tweeter will play 3dB lower. To return to the neutral setting, slide the switch to the middle position. (See Diagram 4)

### Bass Adjustment (CRS8 Three & Four):

The switch labeled BASS allows for 6dB of bass (low frequency) adjustment. Your speakers were shipped with the bass set to neutral, resulting in 6Ω of impedance. This setting provides the flattest bass frequency response. If you desire more bass, roll the switch towards "+" and the bass will play 3dB higher and lower the impedance to 4Ω. If you want less bass, roll the switch towards "-" and the bass will play 3dB lower and increase the impedance to 8Ω. This setting provides a more linear bass frequency response. To return to the neutral setting, slide the switch to the middle position. (See Diagram 5) Remember that altering the impedance affects the number of speakers able to be driven by an amplifier. If multiple pairs of speakers are to be driven by one amplifier, SpeakerCraft suggests using the lowest output position (switch rolled towards the "-" position) until it is determined that the amplifier will operate properly with the speakers switched to a higher output mode. If you want to safely operate multiple pairs of speakers, consider purchasing SpeakerCraft S4 or S8 Speaker Selectors.

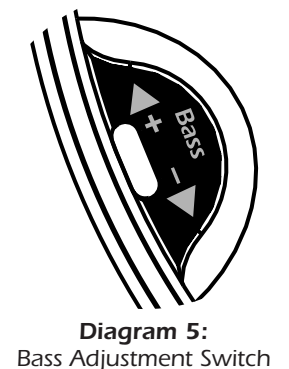
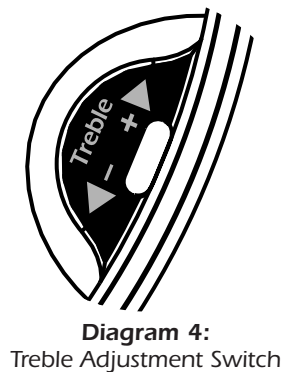
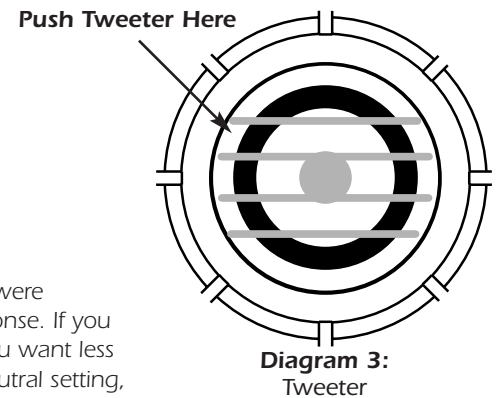

## SPEAKER INSTALLATION

**Note:** Your CRS8 Series speakers may have come with the optional Jawz™ speaker wire connector. Before using Jawz™, please follow the instructions included with the connector.

The unique integral four foot mounting system incorporated into each CRS8 speaker allows for a quick installation by following these easy steps:

1. Remove the grille. It may be necessary to push one or two of the mounting screws and its attached foot towards the baffle and against the inside surface of the grille to force the grille out of its retaining groove.
2. Attach the speaker cable (observing the proper polarity with your amplifier, + to + and - to -). Make sure the left channel of the amplifier is connected to the left speaker, and the right channel is connected to the right speaker.

3. Make sure the mounting feet are turned inward to clear the opening, and insert the speaker into the ceiling. Position the speaker into the hole. **Note:** The flange of the speaker is designed to flex and conform to any small imperfections in the ceiling's surface. Tighten the four screws on the front of the baffle only enough to make the flange become snug against the ceiling. As you tighten the screws, the feet will automatically flip into an outward position (See Diagram 6), thereby clamping the drywall between the feet and the flange. **CAUTION:** Over tightening may warp the baffle, crack the ceiling, cause flange to distort, and make the grille difficult to install.
4. Push the grille firmly into the slot in the speaker baffle.

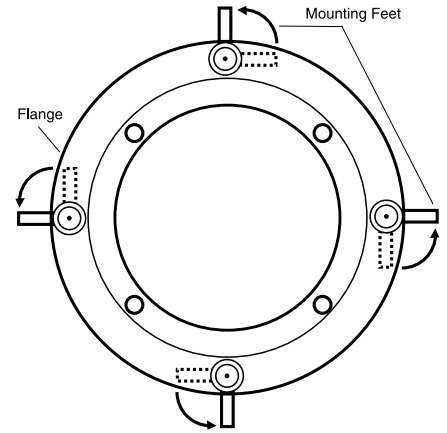

**Diagram 6:**  
Mounting Feet

## PAINTING THE SPEAKERS

If you plan to paint your speakers, we recommend that it be done prior to installation. If you plan to paint your speakers sometime in the future, it is best to remove them by simply reversing the steps for "SPEAKER INSTALLATION" on page 2. If it is necessary to paint the speakers while they are still in the ceiling, the paint masks provided in the carton must be installed in place of the grille while the flange is being painted with the ceiling. The grilles can also be painted, however, great care should be taken not to clog the holes, as this will greatly reduce the sound quality of the speakers. Before painting the grilles, remove the under grille material. Put this material back into place once the grille has been painted. SpeakerCraft recommends only light spray painting, using 5 parts thinning agent to 1 part paint. Do not paint the grilles while they are attached to the speaker. If it is necessary to paint the under grille material, follow the same procedure used to paint the grilles.

## SPECIAL FIRE WALL INSTALLATION

If you plan to mount your speakers in a fire-rated ceiling, you should purchase SpeakerCraft 8" Round Sound Enclosures, model #SE1410. The metal enclosures mount easily between joists, and contain a standard electrical type connector for connections of your speaker cable directly to the speaker.

## LIMITED LIFETIME WARRANTY

SpeakerCraft Inc. warrants to the original retail purchaser **only** that this SpeakerCraft product will be free from defects in materials and workmanship, provided the speaker was purchased from a SpeakerCraft Authorized Dealer.

Defective products must be shipped, together with proof of purchase, prepaid insured to the SpeakerCraft Authorized Dealer from whom they were purchased, or to the SpeakerCraft factory at the address listed on this installation instruction manual. Freight collect shipments will be refused. It is preferable to ship this product in the original shipping container to lessen the chance of transit damage. In any case, the risk or loss or damage in transit is to be borne by the purchaser. If, upon examination at the Factory or SpeakerCraft Authorized Dealer, it is determined that the unit was defective in materials or workmanship at any time during this warranty period, SpeakerCraft or the SpeakerCraft Authorized Dealer will, at its option, repair or replace this product at no additional charge, except as set forth below. If this model is no longer available and can not be repaired effectively, SpeakerCraft, at its sole option may replace the unit with a current model of equal or greater value. In some cases where a new model is substituted, a modification to the mounting surface may be required. If mounting surface modification is required, SpeakerCraft assumes no responsibility or liability for such modification. All replaced parts and product become the property of SpeakerCraft Inc. Products replaced or repaired under this warranty will be returned to the original retail purchaser, within a reasonable time, freight prepaid.

This Warranty does not include service or parts to repair damage caused by accident, disaster, misuse, abuse, negligence, inadequate packing or shipping procedures, commercial use, voltage inputs in excess of the rated maximum of the unit, or service, repair or modification of the product which has not been authorized or approved by SpeakerCraft. This Warranty also excludes normal cosmetic deterioration caused by environmental conditions. This Warranty will be void if the Serial Number on the product has been removed, tampered with or defaced.

This Warranty is in lieu of all other expressed warranties. If the product is defective in materials or workmanship as warranted above, the purchaser's sole remedy shall be repair or replacement as provided above. In no event will SpeakerCraft be liable for any incidental or consequential damages arising out of the use or inability to use the product, even if SpeakerCraft Inc. or a SpeakerCraft Inc. Authorized Dealer has been advised of the possibility of such damages, or for any claim by any other party. Some states do not allow the exclusion or limitation of consequential damages, so the above limitation and exclusion may not apply.

All implied warranties on the product are limited to the duration of this expressed Warranty. Some states do not allow limitation on the length of an implied warranty. If the original retail purchaser resides in such a state, this limitation does not apply.



## SPEAKER SPECIFICATIONS

	<b>CRS8 One</b>	<b>CRS8 Two</b>
Speaker Type:	2-Way In-Ceiling	2-Way In-Ceiling
Woofer:	8" Polypropylene Cone	8" Glass Composite Cone
Tweeter:	Pivoting 1" Silk Dome	Pivoting 1" Silk Dome
Impedance:	8Ω	8Ω
Sensitivity:	89dB 1W/1m	90dB 1W/1m
Frequency Adjustments:	None	Front-Mounted 3 Position ±3dB Treble Adjustment Switch
Frequency Response:	40Hz - 20kHz ± 2dB	40Hz - 20kHz ± 2dB
Power Recommendations:	5-100 watts (undistorted)	5-100 watts (undistorted)
Diameter x Depth:	11 15/16" x 3 3/4"	11 15/16" x 3 3/4"
Ceiling Cut Out:	9 3/4"	9 3/4"
	<b>CRS8 Three</b>	<b>CRS8 Four</b>
Speaker Type:	2-Way In-Ceiling	2-Way In-Ceiling
Woofer:	8" Aluminum Cone	8" Aluminum/Magnesium Cone
Tweeter:	Pivoting 1" Aluminum Dome	Pivoting 1" Aluminum/Magnesium Dome
Impedance:	8/6/4Ω, depending on switch settings	8/6/4Ω, depending on switch settings
Sensitivity:	90dB 1W/1m	90dB 1W/1m
Frequency Adjustments:	Front-Mounted 3 Position ±3dB Treble Adjustment Switch & ±3dB Bass Adjustment Switch	Front-Mounted 3 Position ±3dB Treble Adjustment Switch & ±3dB Bass Adjustment Switch
Frequency Response:	38Hz - 20kHz ± 2dB	36Hz - 20kHz ± 2dB
Power Recommendations:	5-125 watts (undistorted)	5-150 watts (undistorted)
Diameter x Depth:	11 15/16" x 3 3/4"	11 15/16" x 3 3/4"
Ceiling Cut Out:	9 3/4"	9 3/4"

In our attempt to constantly improve our products, features and specifications are subject to change without notice.

SpeakerCraft offers a variety of accessories to make your installation of these speakers and other SpeakerCraft products easy, economical, and professional. Contact your authorized SpeakerCraft Dealer for more information.

Should you have any questions regarding this, or any other SpeakerCraft product, please call our toll-free service hotline at 1-800-448-0976. We are available to assist you every weekday, except holidays, between the hours of 7:00 a.m. and 5:00 p.m. PST.