

911 Guardian Phone

The World's Only Wearable Emergency Phone

OPERATING INSTRUCTIONS

Model No. 30911

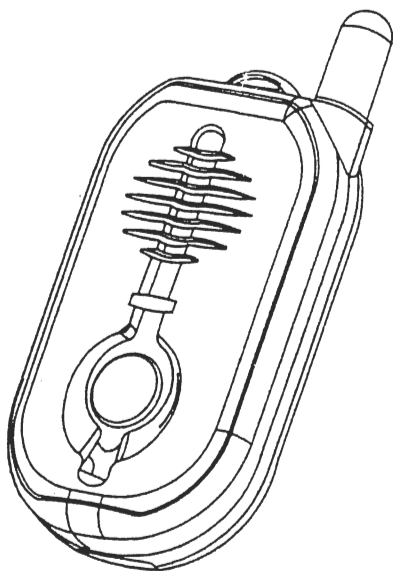

Note: Battery must be installed before use.

PLEASE READ THIS MANUAL COMPLETELY AND SAVE IT FOR REFERENCE.

Thank you for choosing the 911 Guardian Phone – your personal link to help when you need it.

Contents:

The items below are included with your 911 Guardian Phone. Additional parts or replacements can be ordered from DesignTech, International by calling our Customer Service department at 703-866-2005.



Pendant

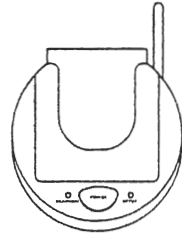

Base Unit

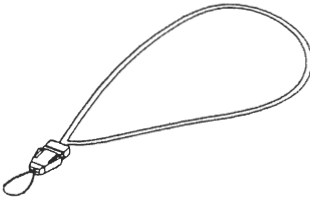

Lanyard

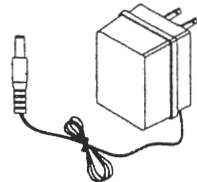

AC Adapter

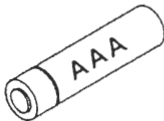

AAA Alkaline Battery



Phone Cord



Screwdriver

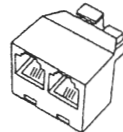

Line Splitter

Optional Accessories:

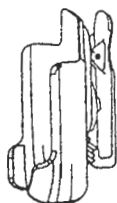

Belt Clip



**Battery Backup
#30912**

TABLE OF CONTENTS

Installing the battery	4
Locating the base unit	4
Overview of the 911 Guardian Phone	5
Pendant features	5
Base features	6
Connecting the 911 Guardian Phone	
The standard connection	6
Connecting a second phone	7
If your home has DSL	7
Operating the 911 Guardian phone	
About the pendant	7
Installing and replacing the battery	8
Attaching the lanyard	8
Water resistance	8
Battery check	9
System check	10
Emergency dialing using the panic button	11
Hanging up	11
Troubleshooting Guide	12

Installing the Battery:

It is important to know that the PENDANT requires one AAA battery. We recommend using a fresh, high quality alkaline or lithium cell from a recognized brand. Under normal use, the unit will remain on standby and ready for use for at least six months. When activated during an emergency, you can talk for a minimum of 30 minutes. Follow the instructions below to install the battery which came with your kit.

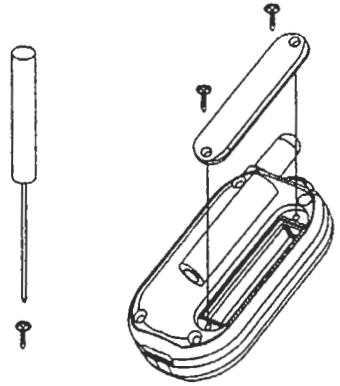

To insure that your 911 Guardian Phone will be ready when you need it, replace the battery every six months.

Locating the Base Unit:

For best results and longest range, locate the BASE UNIT in an area away from household appliances which could present electrical interference. These include microwave ovens, televisions, electric mixers or blenders, hairdryers, or other cordless phones.

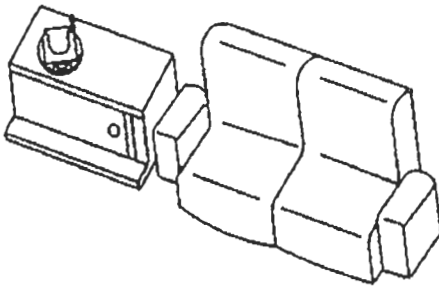

Good Location

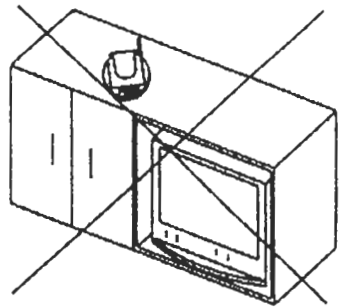

Bad Location

If more than one 911 Guardian Phone is to be used in one home, it is recommended that the BASE UNITS be located at least 10' apart. Do not install more than two 911 Guardian Phones in one home.

Overview Of The 911 Guardian Phone:

The 911 Guardian Phone is a tiny cordless speaker phone, small enough to be worn around your neck. It is smaller than most cell phones.

By pressing a single button, the 911 Guardian Phone automatically dials the universal 911 emergency number. You will then be able to speak directly to the 911 operator about your emergency.

It has enough range to cover most homes and the area close by outside. It is NOT a cell phone, and therefore will not work far from your home. It is designed to be used primarily inside the home.

The 911 Guardian Phone PENDANT has its own replaceable battery. The battery must be installed prior to use. It will last at least six months in standby mode. Because the PENDANT never needs charging, it can be kept with you at all times. We recommend that the PENDANT battery be replaced every six months.

Like most cordless phones, the 911 Guardian Phone must be plugged into a power outlet using an AC adapter (included). It will not work without power. An optional battery backup is available which can keep the 911 Guardian Phone BASE UNIT working for up to 24 hours in case of a power failure. It can be ordered from the Customer Service number at the bottom of this page. Ask for part number 30912.

Pendant Features:

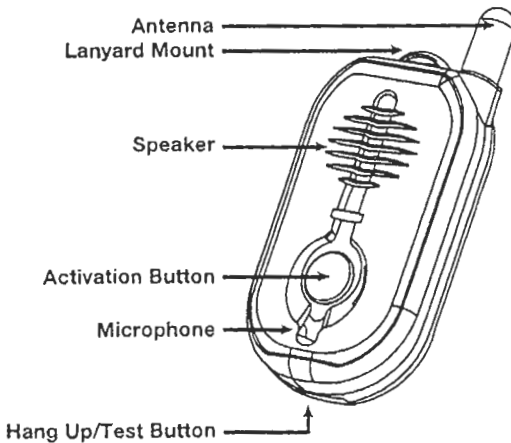

Base Unit Features:

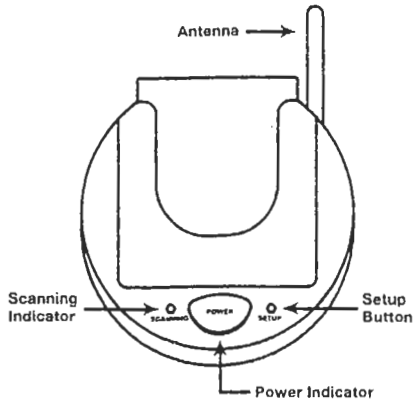

Connecting The 911 Guardian Phone:

The Standard Connection

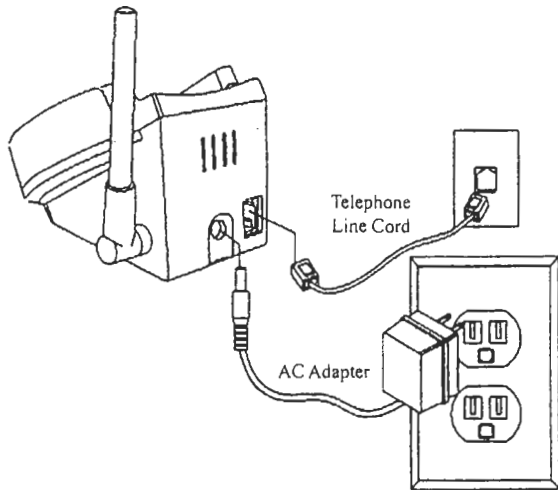

No special phone line or special service is required to use your 911 Guardian Phone. Your phone will work with your existing phone line and existing service. It works the same way as any cordless phone.

Simply plug in the AC ADAPTER and TELEPHONE LINE CORD as shown.

Caution: Do not plug the AC ADAPTER into an outlet which is controlled by a switch. The switch could accidentally be turned off, thus rendering the BASE UNIT inoperable.

Connecting A Second Phone

You may need to plug a conventional telephone into same outlet used by the 911 Guardian Phone. This is done very simply by using the telephone line splitter (included). See illustration on right.

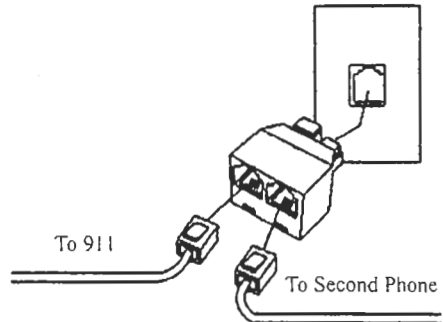

If Your Home Has DSL

If your home has DSL service for your computer, you will need to use a DSL filter in line with the 911 guardian phone OR IT WILL NOT WORK. This filter can be obtained from a local electronics supplier or your DSL service provider. See illustration to the right.

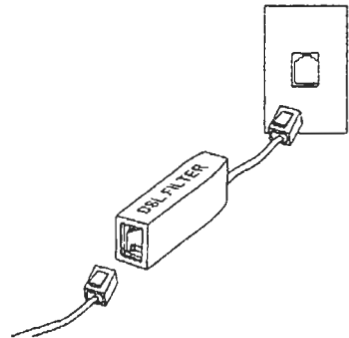

Operating the 911 Guardian Phone

About The Pendant:

The PENDANT is a tiny, cordless speaker phone. It may be worn around the neck, on a belt using the supplied clip, or kept in your pocket.

There is a large blue button on the front of the PENDANT which activates the system and automatically dials the 911 emergency number when pressed for more than ½ second.

Once connected, you can speak directly with the 911 operator and explain the nature of your emergency.

Installing And Replacing The Battery

Please refer to the instructions on page 4.

The PENDANT requires a single AAA alkaline or lithium battery. This battery should only be replaced with a new battery from a well-known quality manufacturer. Once installed, the battery will last for at least 6 months if the PENDANT is not used. When the PENDANT is activated in an emergency, the battery will supply power for at least 30 minutes of talk time.

The battery should be replaced every six months, even if the PENDANT is not used. This is because the PENDANT draws a small amount of current even while in standby mode.

Attaching The Lanyard

If the neck strap is to be used, attach it as shown to the right.

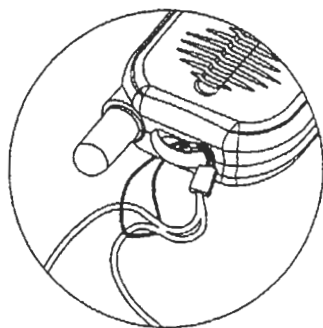

Water Resistance

The 911 Guardian Phone will resist occasional splashes from water, such as in the shower. However, it should never be submerged or exposed to water continuously.

It has been designed and tested to meet the JIS 6 standard for water tightness. "Direct jetting water from any direction shall not enter the enclosure".

Battery Check

The 911 Guardian Phone has a built-in battery tester. When you press the button on the bottom of the PENDANT, a voice announcement will inform you of the battery condition. One of the following messages will be heard:

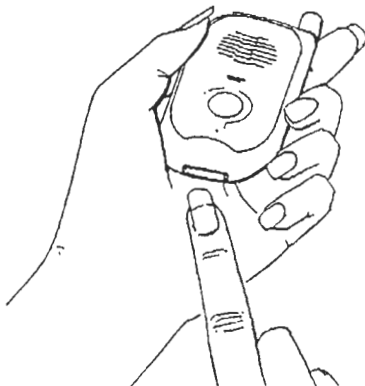

“Battery is OK.”

Check the battery condition once per month.

“Replace battery soon.”

The battery should be replaced within the next few days.

“Replace battery now.”

The battery should be replaced the same day.

Please note: If there is no response after pressing the button for one second or more, the battery is dead and must be replaced immediately.

The battery should be tested once each month. If the battery is tested every day, it will be drained much more quickly and will not last as long.

System Check

The button on the bottom of the case which is used to perform the BATTERY CHECK, will also perform a SYSTEM CHECK. Press and hold this button for more than four (4) seconds. One of the following announcements will be made.



“System check, OK.”

This confirms the following:

Battery status.

The PENDANT is working.

The BASE UNIT is working.

The BASE UNIT is connected to a working phone line.

“System check failed.”

This confirms one or more of the following:

The PENDANT has malfunctioned.

The BASE UNIT has malfunctioned.

The PENDANT and BASE UNIT are not communicating with each other.

The BASE UNIT is not connected to the phone line or can not get a dial tone for some reason.

If you receive a “System check failed.” notification, please refer to the TROUBLESHOOTING guide at the back of this manual to determine the cause.

Emergency Dialing Using the Panic Button

In the event of an emergency, press the blue panic button on the front of the PENDANT. When this button is pressed for more than ½ second, the 911 Guardian Phone will automatically dial 911. When the emergency response operator answers, speak in a normal voice and you will be heard. There is no need to put the PENDANT up to your ear unless you are having trouble hearing. There is no need to hold the PENDANT up to your mouth. You will be clearly heard, even if the PENDANT is an arm's length away.



Hanging Up

You can hang up any time by pressing the BATTERY CHECK button on the bottom of the case.

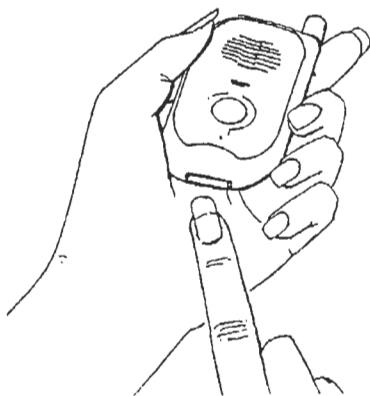

TROUBLESHOOTING GUIDE

What if I can't get the 911 Guardian Phone to work?

Step 1 – Check the PENDANT.

What to do:

Press the BATTERY CHECK/SYSTEM CHECK button on the bottom of the PENDANT.

What to expect:

The a voice should announce the condition of the battery.

A light on the front of the PENDANT will come on.

If nothing happens, the most likely cause is that the battery is dead or has been installed backwards.

If the PENDANT seems to be working, go on to step 2.

Step 2 – Check the connections on the BASE UNIT

What to do:

Make sure the AC ADAPTER is plugged into a live AC outlet and into the BASE UNIT.

What to expect:

The blue POWER light will be on if the BASE UNIT is connected to power.

If the POWER light is on and the BASE UNIT is connected to a working phone line, go on to step 3.

Step 3 – Make sure the PENDANT and the BASE UNIT are talking to each other.

Background information: The PENDANT and the BASE UNIT are connected by a wireless radio link. They must be synchronized to work together. They should have already been synchronized at the factory, but resetting this is simple.

What to do:

Press the “SET” button on the BASE UNIT. The red “SETUP” light will come on.

Press and hold the PANIC BUTTON and the BATTERY CHECK buttons together.

What to expect:

The red light will go out on the BASE UNIT. This indicates the PENDANT and the BASE UNIT are synchronized. At this point, everything should be working fine.

If your 911 Guardian Phone is still not working, call our TECH SUPPORT department at 703-866-2005.

Information The FCC Wants You To Know:

FCC ID: ELG30911

This device complies with Part 15 of the FCC Rules. Operation is subject to the following two conditions: (1) this device may not cause harmful interference, and (2) this device must accept any interference received, including interference that may cause undesired operation.

Privacy of communications may not be ensured when using this phone.

Operating Range:

The operating range of your 911 Guardian Phone will depend on many factors including intervening walls, electrical interference or various appliances such as vacuum cleaners, microwave ovens, mixers, coffee grinders, hair dryers and other sources of electrical noise around the house.

General Warnings And Precautions!

Warning!

The cords on this product and/or accessories contain lead, a chemical known to the State of California to cause birth defects or other reproductive harm. Wash hands after handling.

Warning!

DesignTech International, LLC DOES NOT represent this unit to be waterproof. To reduce the risk of fire, electrical shock, or damage to the unit, DO NOT expose the base unit to rain or moisture.

Warning!

The 911 Guardian Phone is intended for residential use only. It may not work properly if connected to some commercial phone systems.

Warning!

The 911 Guardian Phone works with tone dialing systems only. Do not use if you have pulse dialing only.

Disclaimer:

DesignTech International, LLC. will not be responsible for the improper use of the 911 Guardian Phone, nor will it be responsible for failure resulting from the use of other equipment connected to the same phone line. We will not be responsible for the quality of the phone line or the reliability or quality of the phone service with which the 911 Guardian Phone is used.

DesignTech International, LLC. will not be responsible for the installation of the 911 Guardian Phone. It will not be responsible for the improper use or abuse of this unit.

Important Safety Instructions:

When using your 911 Guardian Phone, please observe the following instructions in order to reduce the risk of personal injury, electrical shock, or fire.

1. Save these instructions for future reference.
2. Read all instructions carefully and make sure you understand them.
3. Unplug this product from the electrical outlet before attempting to clean it. Do not use any liquids for cleaning either the Base Unit or the Pendant. Use only a soft damp cloth.
4. Do not locate the Base Unit near any source of water, such as in the bathroom, near a sink in the kitchen, or the like.
5. Do not open the unit, (except the battery compartment as directed in these instructions) on the Pendant for any reason. Any attempt to open the case of the Base Unit or the Pendant will void the warranty and may damage the unit or prevent it from working properly.

6. Do not use any power source other than that supplied from DesignTech International, LLC specifically for this product. Use of any other power source could damage your unit or make it unsafe.
7. If your unit becomes damaged do not attempt to repair it. Please return it to DesignTech International, LLC for service or replacement as stipulated below under "ONE YEAR LIMITED WARRANTY".

ONE YEAR LIMITED WARRANTY

DesignTech International, LLC warrants to the original consumer/purchaser that this product shall be free of defects in material and workmanship under normal use and circumstances for a period of **one (1) year** from the date of original purchase for use. When the original consumer/purchaser returns the product pre-paid to DesignTech International LLC, 7955 Cameron Brown Court, Springfield, Virginia 22153-2809, USA within the warranty period, and if the product is defective, DesignTech International, LLC will at its option repair or replace such.

This warranty shall constitute the sole liability of DesignTech International, LLC concerning the product. DesignTech International, LLC expressly disclaims all other warranties INCLUDING, WITHOUT LIMITATION, THE WARRANTIES OF MERCHANT ABILITY AND FITNESS FOR A PARTICULAR PURPOSE. NO PERSON, FIRM, OR CORPORATION IS AUTHORIZED TO ASSUME FOR DESIGNTECH INTERNATIONAL, LLC. ANY OTHER LIABILITY IN CONNECTION WITH THE SALE AND USE OF THE PRODUCT. DesignTech International, LLC and agents and distributors will bear no liability whatsoever for incidental or consequential damages or charges of any kind.

Some states do not allow the exclusion or limitation of incidental or consequential damages, so the above disclaimer regarding incidental or consequential damages may not apply to you.

Please fully complete the warranty registration card below and mail with proof of purchase to: DesignTech International, LLC, 7955 Cameron Brown Court, Springfield, Virginia 22153-2809, USA within ten (10) days after date of purchase.

This warranty is void if the product has been damaged or tampered with or if the product or any such parts have been opened. In all cases of damage during shipment, a claim must be filed with the shipping carrier and not with DesignTech International, LLC.

This warranty gives you specific legal rights; you may also have other rights which vary from state to state.

OUT OF WARRANTY REPAIRS

If the warranty period has expired or if you are not the original owner of the product, DesignTech International, LLC will at its option either (1) replace this product with a functionally similar (but not necessarily identical) refurbished product or (2) repair the original product and return it to the original consumer/purchaser after payment of repair/replacement charges has been received.



7955 Cameron Brown Court
Springfield, Virginia 22153

Tel: 703-866-2005

www.911GuardianPhone.com